

Whoever believes in Jesus
will have eternal life.

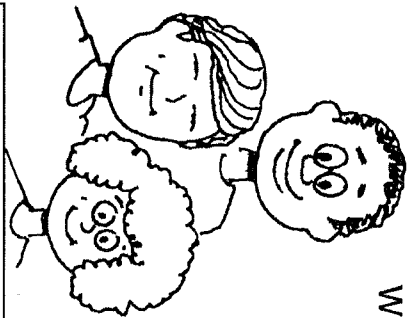

Trace the letters below.

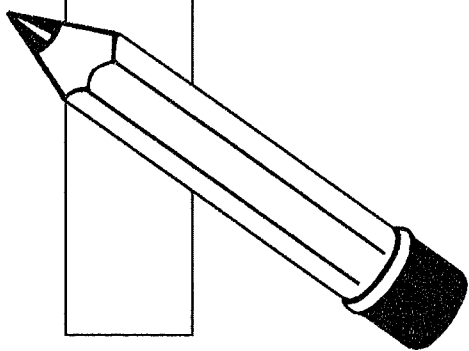

Believe

John

Jesus.

Children's Worship Bulletin™



Ages 3+

March 10, 2024 • John 3:14-21

Light and Life

Jesus said that God loves
the people of the whole world.

Add yourself to this crowd.

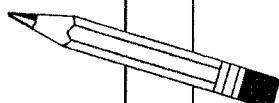
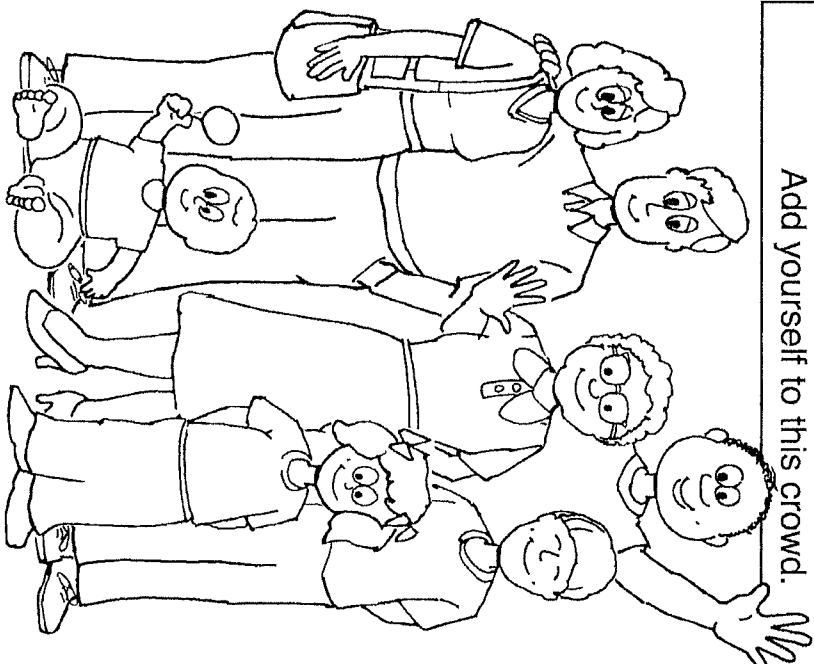

God sent Jesus to the world.



Jesus is like a light for the world.

Connect the dots.
ABCDEFGHIJKL
1 2 3 4 5 6 7 8

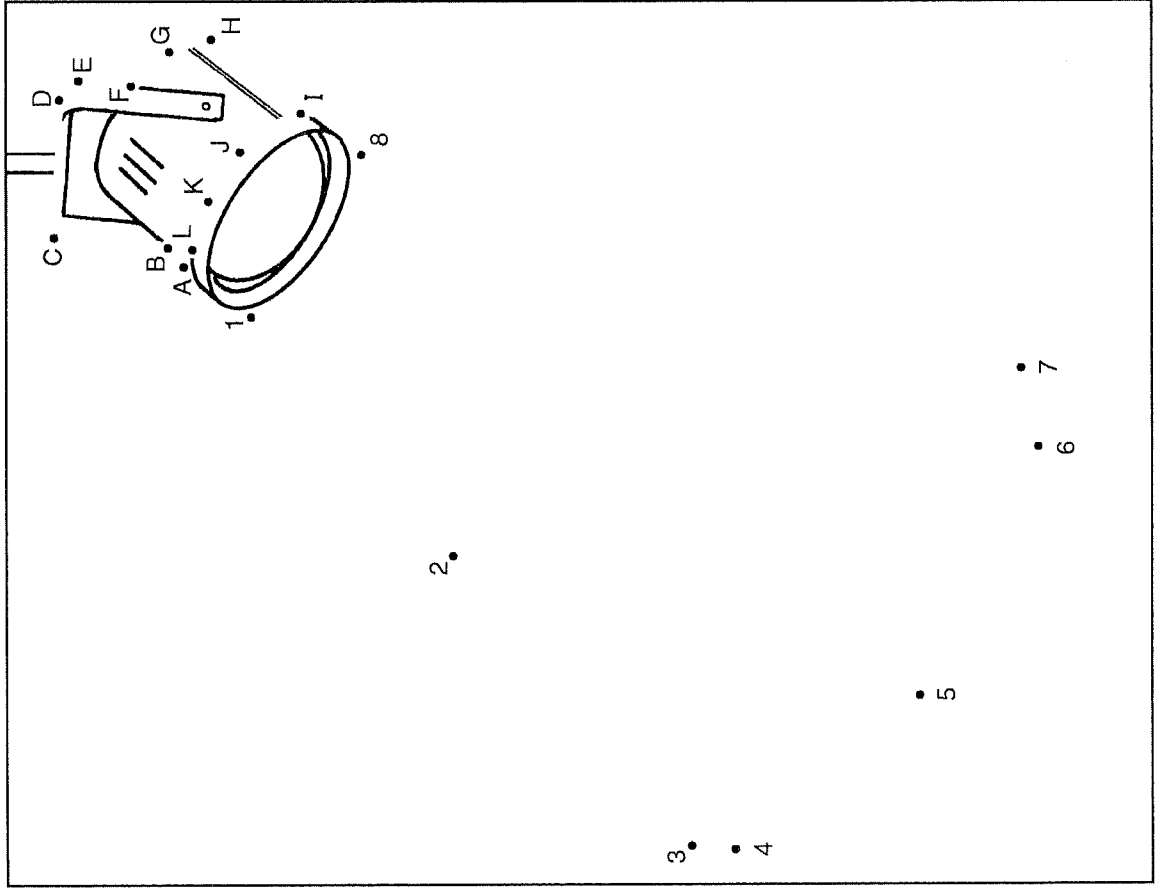

Find the words of Jesus.

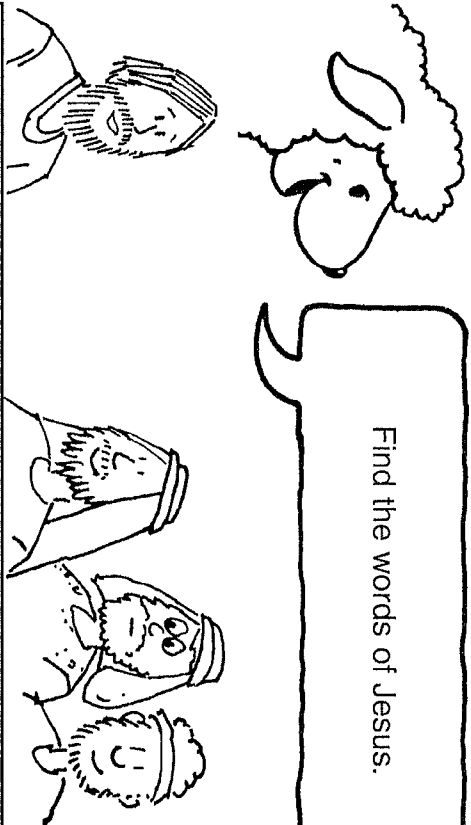

Finish the words below using these letters.
Then read the verse.

ght	en	es	ly	ne	th
tr	at	mes	h	ay	
ever	en	th	ough	as	

"Who _____ liv _____ by the _____ uth
co _____ to the li _____, so _____ at it

m _____ be se _____ plain _____ at
wh _____ they _____ ave do _____ h _____

be _____ thr _____ God."

Children's Worship Bulletin™



Ages 7+

March 10, 2024 • John 3:14-21



Light and Life

If you believe in Jesus,
God promises something wonderful!
What is it?

Add and subtract words and letters.

1.  - B D +  - K I +

 - I G +  - B L = _____

2.  - G H T +  - A N

+  - A R = _____

God did something very special for everyone
 because God loves us.
 How much does God love us?

1 - For	2 - gave	3 - Him	1 - God
2 - His	3 - shall	1 - so	2 - only
3 - not	1 - loved	2 - Son	3 - perish
1 - the	2 - that	3 - but	1 - world
2 - whoever	3 - have	1 - that	2 - believes
3 - eternal	1 - He	2 - in	3 - life

Reading from left to right, write all of the 1's in order. When you reach the last 1, return to the top and write all of the 2's in order. Then return to the top and write all the 3's in order.

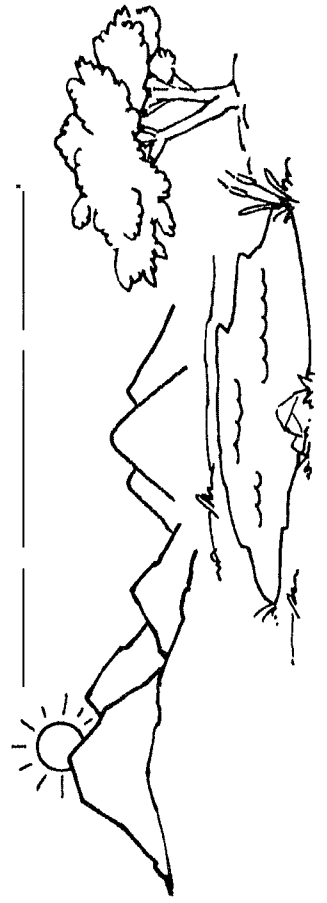

Why did God send Jesus to us?

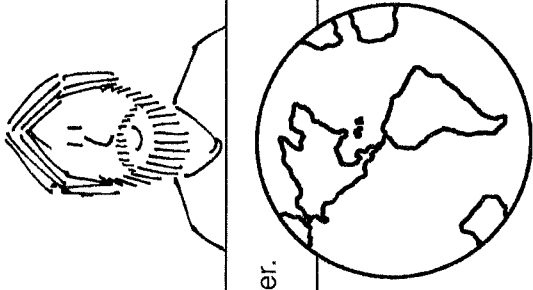

Use the calculator to find the answer.

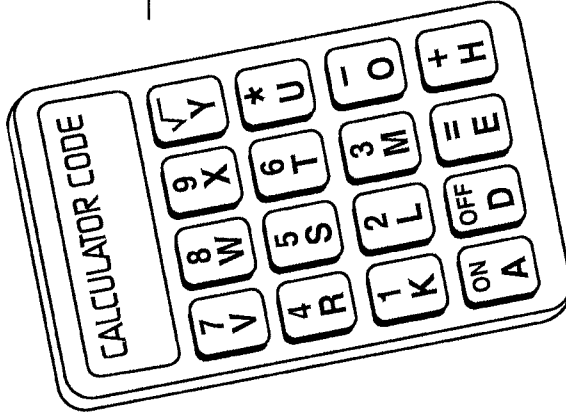

$$6 \quad - \quad =$$

$$5 \quad \text{ON} \quad 7 \quad =$$

$$6 \quad + \quad =$$

$$8 \quad - \quad 4 \quad 2 \quad \text{OFF}$$

